

# MD 880-879 TAB Chain Series

Standart Radius Sideflexing Chains



## MD 880-879 TAB Technical Information

MD 880-879 TAB SERIES STANDARD RADIUS SIDEFLEXING CHAINS

PRODUCT CODE	WIDTH ( W )		PLATE THICKNESS ( S )	RADIUS ( R )	TENSILE STRENGTH		WEIGHT
	mm	inch			Kg/m	N/m	
MD 880 TAB-K325-LF	82,5	3,25	4	400	200	2000	0,95
MD 880 TAB-K400-LF	101,6	4,00	4	400	200	2000	1,05
MD 880 TAB-K450-LF	114,3	4,50	4	400	200	2000	1,15
MD 879 TAB-K600-LF	152,4	6,00	4,8	400	220	2200	1,35
MD 879 TAB-K750-LF	190,5	7,50	4,8	400	220	2200	1,55

\* Selflubricating low friction acetal resin, brown-coloured.

\* Pins in special chrome-nickel 304 stainless steel

\* Standard packing lengths = 80 pitches = 3,048 m

## MD 880-879 TAB Technical Drawings

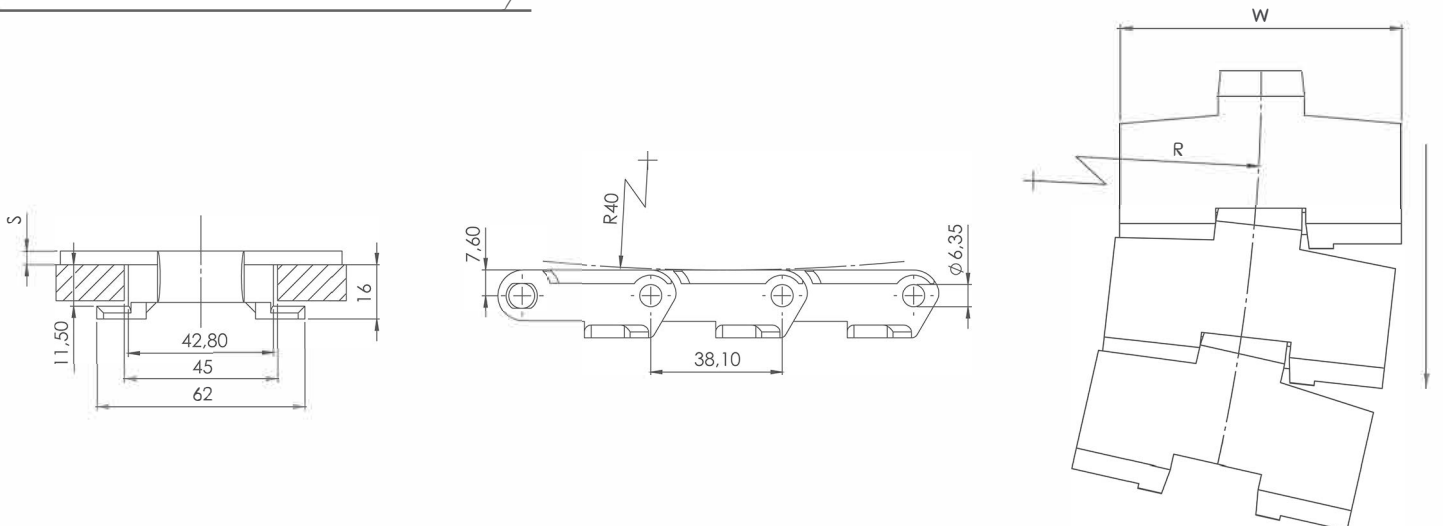

## MD 820 Sprockets Technical Drawings

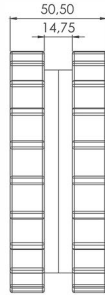
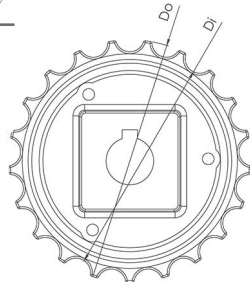

Classic Sprocket Series MD820

Product Code	Number of Teeth	Do (mm)	Di (mm)	Round Bore (Ø)
MD 820	21	128	114	25 30
MD 820	25	152	138	25 30

\* Special sprockets and hub size are being manufactured on your request.

## MD 880 Sprockets Technical Drawings

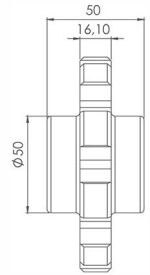
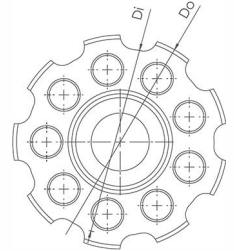

Classic Sprocket Series MD880

Product Code	Number of Teeth	Do (mm)	Di (mm)	Round Bore (Ø)
MD 880	9	111	97	25 30
MD 880	11	135	121	25 30

\* Special sprockets and hub size are being manufactured on your request.

## MD 1701 R Sprockets Technical Drawings

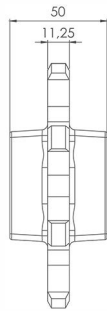
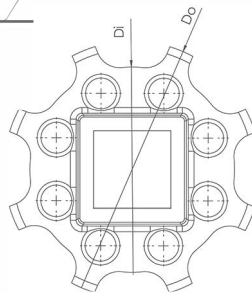

Classic Sprockets Series MD1701

Product Code	Number of Teeth	Do (mm)	Di (mm)	Round Bore (Ø)	Round Bore (Ø)
MD 1701 R	8	132	107	25 30	40 x 40
MD 1701 R	10	166	107	25 30	40 x 40

\* Special sprockets and hub size are being manufactured on your request.

## Flexi Chains Sprocket Technical Drawings

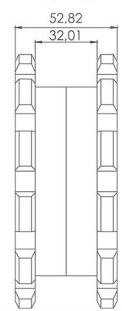
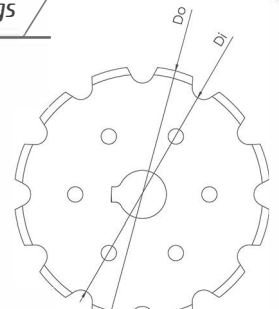

Classic Sprockets Series Flexi Chains

Product Code	Number of Teeth	Do (mm)	Di (mm)	Round Bore (Ø)	Round Bore (Ø)
FLEXI CHAIN	12	133	115	25 30	40 x 40

\* Special sprockets and hub size are being manufactured on your request.

## MD 600 S Sprockets Technical Drawings

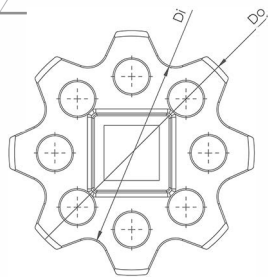

Classic Sprockets Series MD600

Product Code	Number of Teeth	Do (mm)	Di (mm)	Round Bore (Ø)	Square Bore
MD 600	8	177	138	25 30	40 x 40
MD 600	10	221	176	25 30	40 x 40

\* Special sprockets and hub size are being manufactured on your request.